

Home

Products

Distributors

Technical

Contact Us

Other Options

Path: [Home](#) > [Enclosure Index](#) > Diecast Aluminum - Light Duty Watertight (With Bottom Flange)



[click to enlarge](#)































[click to enlarge](#)



[click to enlarge](#)

Key Features:

- Rugged, diecast aluminum alloy (tough yet easy to machine), electronic instrument enclosure.
- Lid screws are exposed for easy enclosure access (if you require higher security see our [watertight flanged lid version](#)).
- Bottom flange is an aluminum plate, welded onto the base of the enclosure.
- Lap joint construction with a factory poured silicone rubber gasket around the perimeter of the lid provides protection against access of dust and water.
- Silicone rubber gasket remains flexible from -62 to +232°C (-80 to +450 °F).
- Unpainted version is vibra finished for a smooth surface with no sharp edges.
- Painted version is painted with tough polyester powder paint for a lasting finish, even after machining. Paint is only applied to the exterior surface. Black screws are included to enhance appearance.
- Four (or 6 in 1590D, 1590DD & 1590E, 8 in 1590F) 6-32 x 1/2" stainless steel machine screws secure lid - into factory tapped holes.
- Screws use neoprene "O" rings (included).
- Designed to meet IP65.
- Low side wall draft angle (2 degrees or less) for easy P.C. board mounting.
-  Link here to [photo tables](#) of each part number - **note:** regular, unflanged version shown for sizing

Part Number	Color	Reader File	 Drawing File Size	AutoCAD .dwg File (zipped)	.zip File Size	Units	Length	Width	Enclosure Depth (Less Lid)
1590WLLBF 1590WLLBFBK	Unpainted Black		133K		185K	Inches	1.97	1.97	0.83
						mm	50	50	21
1590WLBF 1590WLBFBK	Unpainted Black		141K		172K	Inches	1.99	1.99	1.06
						mm	51	51	27
1590WHF 1590WHFBK	Unpainted Black		145K		273K	Inches	2.07	1.5	1.06
						mm	52.5	38	27
1590WYF 1590WYFBK	Unpainted Black		121K		177K	Inches	3.62	3.62	1.50
						mm	92	92	38
1590WAF 1590WAFBK	Unpainted Black		129K		155K	Inches	3.64	1.52	1.06
						mm	93	39	27
1590WGF 1590WGFBK	Unpainted Black		136K		263K	Inches	3.94	1.97	0.83
						mm	100	50	21
1590WSF 1590WSFBK	Unpainted Black		135K		227K	Inches	4.35	3.21	1.57
						mm	111	82	40
1590WBF 1590WBFBK	Unpainted Black		128K		174K	Inches	4.39	2.34	1.06
						mm	112	60	27
1590WBBF 1590WBBFBK	Unpainted Black		166K		177K	Inches	4.67	3.68	1.18
						mm	119	94	30
1590WQF 1590WQFBK	Unpainted Black		132K		427K	Inches	4.70	4.70	1.1
						mm	120	120	28
1590WUF 1590WUFBK	Unpainted Black		124K		268K	Inches	4.70	4.70	2.17
						mm	120	120	55
1590WVF 1590WVFBK	Unpainted Black		118K		238K	Inches	4.70	4.70	3.54
						mm	120	120	90
1590WCF 1590WCFBK	Unpainted Black		128K		288K	Inches	4.72	3.70	2.07
						mm	120	94	53

1590WTF 1590WTFBK	Unpainted Black		133K		211K	Inches	4.74	3.13	2.17
						mm	121	80	55
1590WN1F 1590WN1FBK	Unpainted Black		125K		244K	Inches	4.77	2.6	1.39
						mm	121.1	66	35.3
1590WKKF 1590WKKFBK	Unpainted Black		123K		214K	Inches	4.92	4.92	2.10
						mm	125	125	53
1590WKF 1590WKFBK	Unpainted Black		115K		120K	Inches	4.92	4.92	2.95
						mm	125	125	75
1590WJF 1590WJFBK	Unpainted Black		113K		140K	Inches	5.71	3.74	1.77
						mm	145	95	45
1590WP1F 1590WP1FBK	Unpainted Black		119K		199K	Inches	6.01	3.24	1.81
						mm	153	82	46
1590WDDF 1590WDDFBK	Unpainted Black		130K		314K	Inches	7.40	4.70	1.30
						mm	188	119.5	33
1590WDF 1590WDFBK	Unpainted Black		130K		347K	Inches	7.38	4.70	2.05
						mm	188	120	52
1590WEF 1590WEFBK	Unpainted Black		126K		213K	Inches	7.38	4.70	3.07
						mm	188	120	78
1590WFF 1590WFFBK	Unpainted Black		130K		378K	Inches	7.38	7.38	2.48
						mm	188	188	63
1590WR1F 1590WR1FBK	Unpainted Black		128K		229K	Inches	7.55	4.38	2.24
						mm	192	111	57



Link here to [photo tables](#) of each part number - **note:** regular, unflanged version shown for sizing

NOTES:

- For more detailed drawing of the enclosure refer back to our 1590 series (without flanges) listed above. This allowed more room on the drawings for other details.
- Dimensions are for enclosure (length does not include flanges)

- Add 0.16" (4 mm) to enclosure depth for lid
 - For other drawing information or if you prefer .dwg versions of these drawings e-mail drawings@hammondmfg.com
 - Available in natural vibra finish OR in light textured, powder paint in Black.
 - This series is the same as our 1590 diecast aluminum except with a bead of rubberlike silicone around the perimeter of the lid.
-

DOWNLOAD

catalog pages on this series (132K) [9C-1590WF.pdf](#)

Exactly what you are looking for???
Link to our stocking distributors - most have "on-line" pricing, stock check and ordering!!!

[Our Distributors](#)

Order from your favorite distributor

[Home](#) | [Products](#) | [Distributors](#) | [Technical](#) | [Contact Us](#) | [Other Options](#)

Top View of Assembly

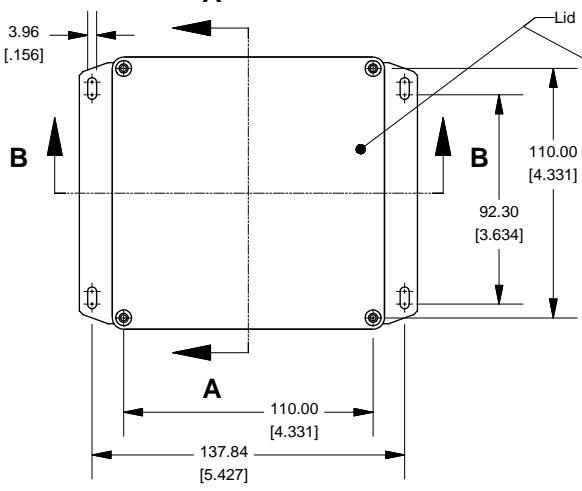

SECTION A-A End View of Assembly

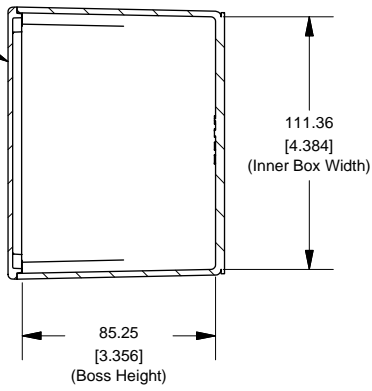

Series 1590TF (Flanged Box)

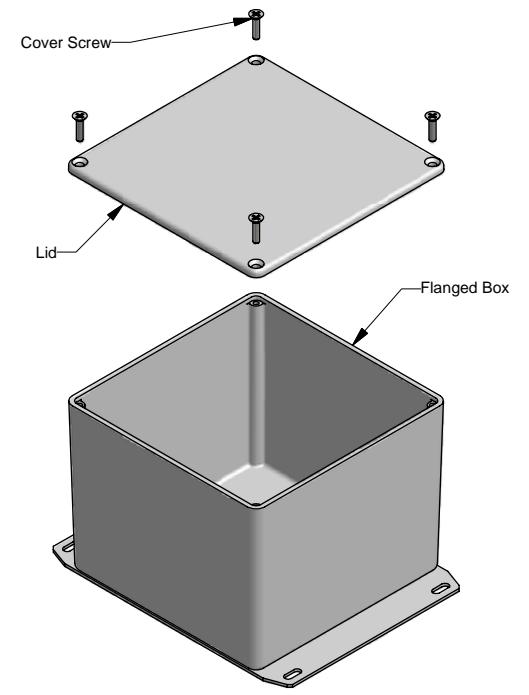

SECTION B-B Side View of Assembly

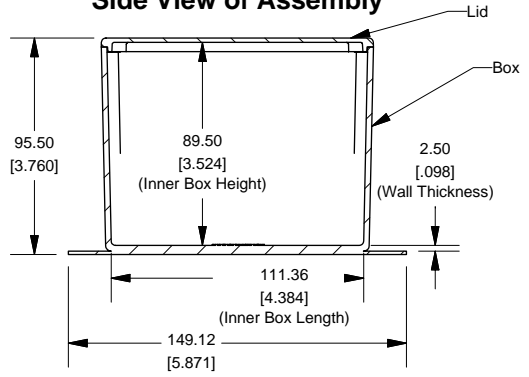

Top View Looking Inside Box

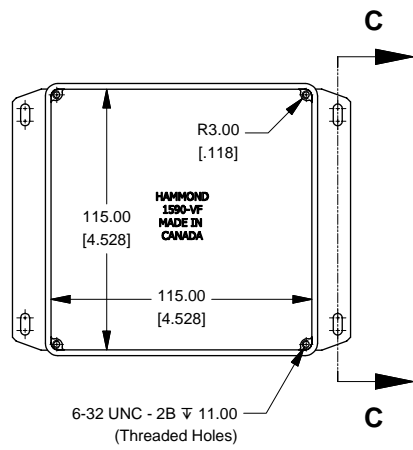

SECTION C-C Side View of Slot

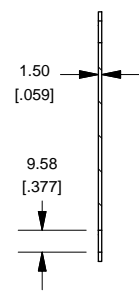

Lid

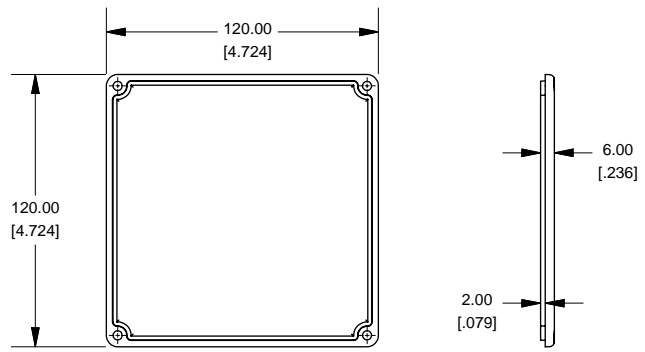

NOTE
 Purchased assembly includes box, lid and 4 cover screws.
 Box and lid are made from Diecast Aluminum Alloy (alloy type 360.1).
 Flanges are made from Stamped Aluminum 5052-H32

PART NUMBERS	
1590VF Enclosure	
Unfinished	1590VF
Black Textured Powder Paint	1590VFBK
1590VF Liquid Resistant Enclosure (Silicon Factory Installed Gasket)	
Unfinished	1590WVF
Black Textured Powder Paint	1590WVFBK
ACCESSORIES	
Unfinished	
Cover Screws (Pkg 100) [6-32 x 1/2" Nickel Plated Screws]	1590MS100
Black Textured Powder Paint	
Cover Screws (Pkg 50) [6-32 x 1/2" Stainless Steel Black Screws]	1590MS50BK

